

Rinnai

Portable Unflued Gas Convection Heaters With Electric Boost Operation Manual

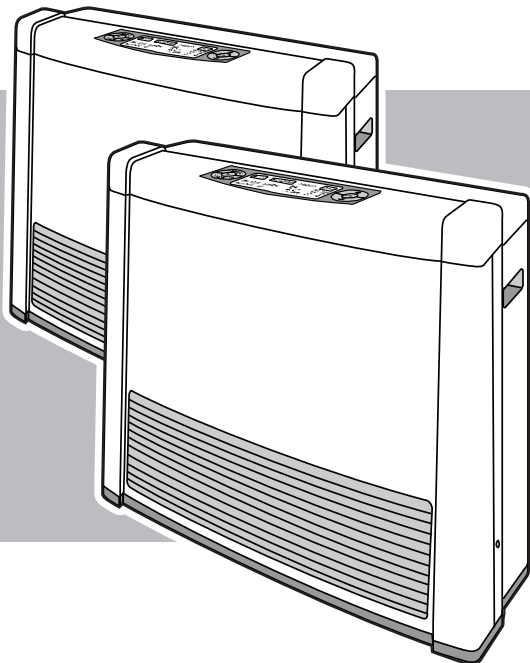

To Suit Models
Avenger 25 Plus
Capella 18 Plus

This appliance shall be installed in accordance with:

- Manufacturer's Installation Instructions
- Current AS/NZS 3000 & AS/NZS 5601
- Local Regulations and Municipal Building Codes

This appliance must be installed, serviced and repaired by an Authorised Person.



The Australian
Gas Association
All Rinnai gas products
are A.G.A. certified.



N10378

This page intentionally blank.

TABLE OF CONTENTS

ABOUT YOUR NEW AVENGER/CAPELLA PLUS	2
CONTROL PANEL LAYOUT	3
REMOTE CONTROL	4
FEATURES	5
IMPORTANT POINTS	6
CUSTOMER OPERATING INSTRUCTIONS	11
HOW TO OPERATE THE HEATER	12
ADJUSTING TEMPERATURES.....	13
HEATER MODES & FUNCTIONS.....	14
SETTING HEATER MODES.....	15
SETTING CLOCK.....	16
PROGRAMMING THE ON/OFF TIMERS.....	17
OPERATING THE ON/OFF TIMERS	18
PRE-HEAT	18
OVERRIDE FUNCTION	19
USING THE REMOTE CONTROL	19
CHILD LOCK	20
SAFETY DEVICES	20
CARE OF HEATER	21
TROUBLE SHOOTING.....	22
ERROR CODES	23
SPECIFICATIONS	24
CONTACT INFORMATION	26

ABOUT YOUR NEW AVENGER/CAPELLA PLUS

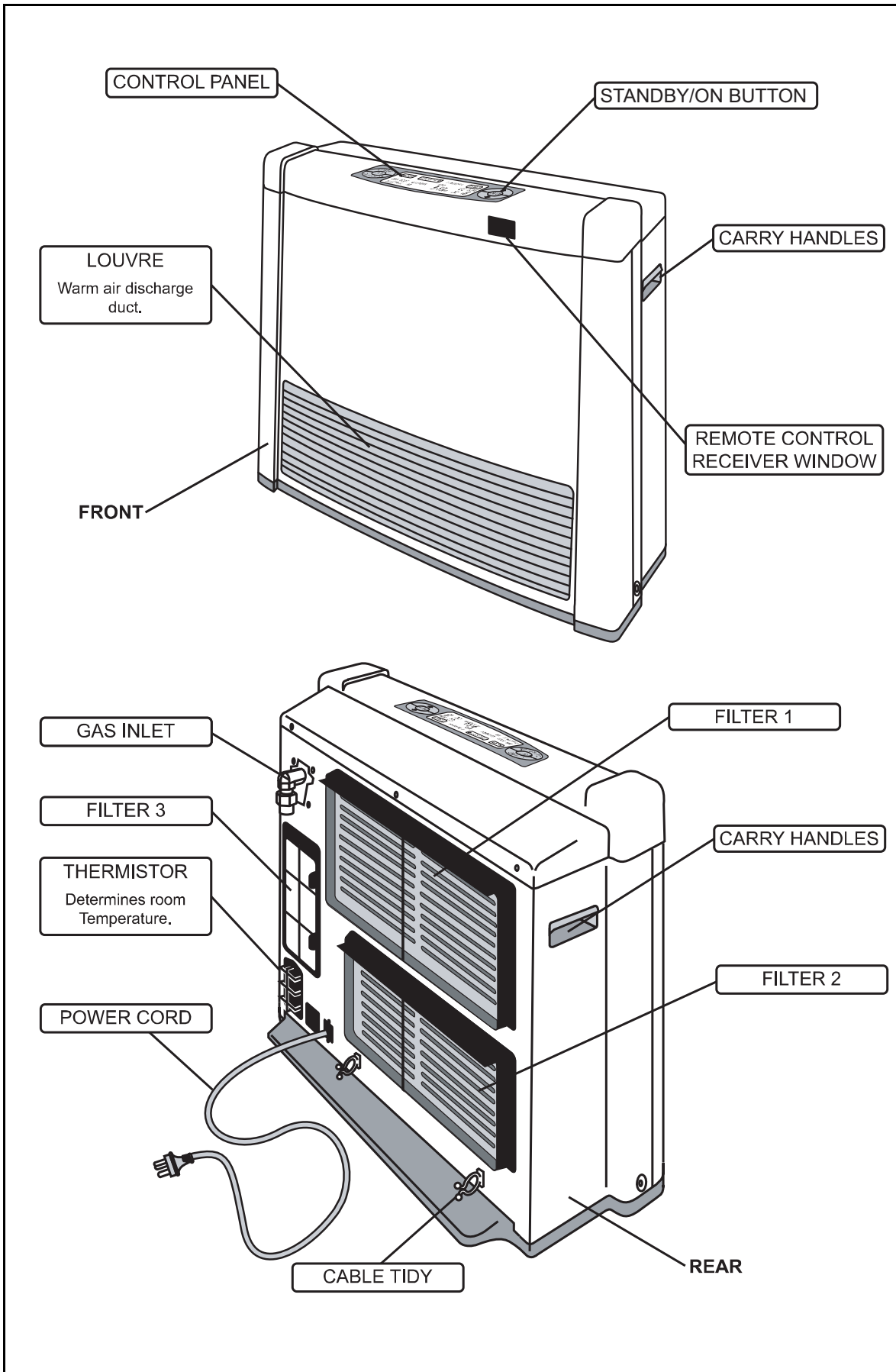

CONTROL PANEL LAYOUT

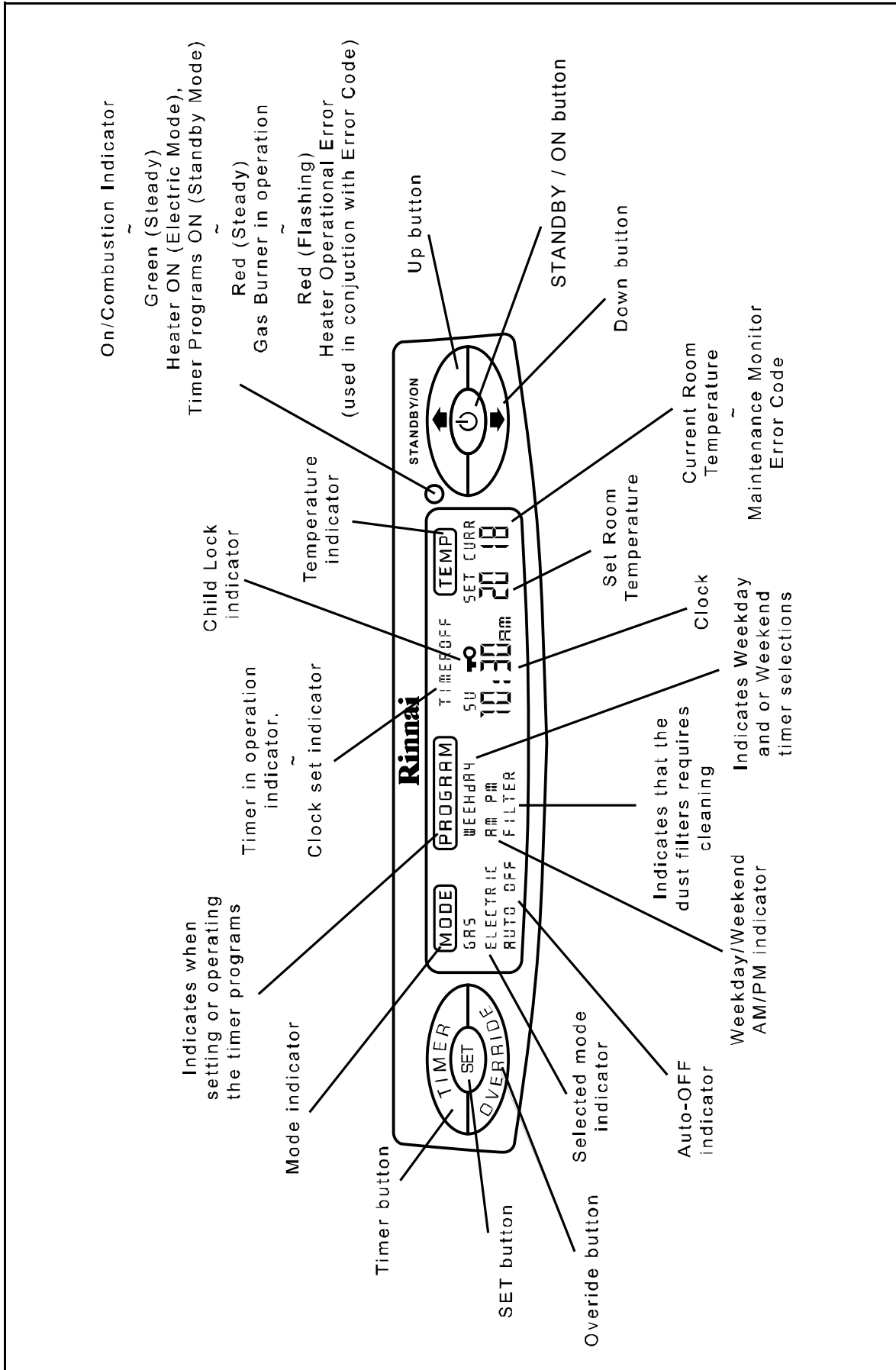

REMOTE CONTROL

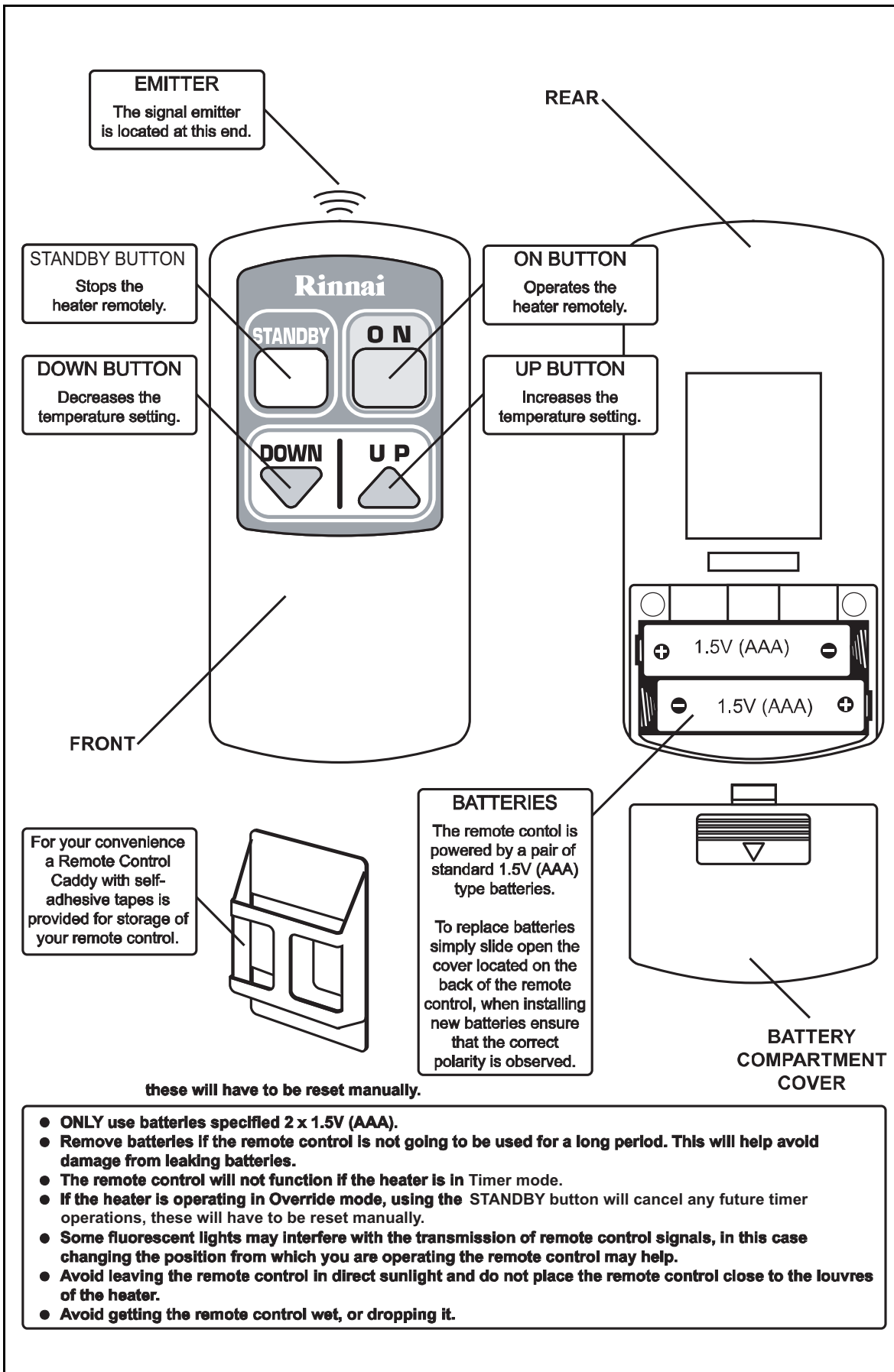

FEATURES

PUSH BUTTON IGNITION

Only one touch of the STANDBY/ON switch is required to operate the heater.

CHILD LOCK

When the Child Lock is activated all controls other than the STANDBY switch will be locked. Deactivating the lock releases the controls. If the lock is activated when the appliance is in STANDBY, all functions will be locked.

MEMORY

The micro-computer records selected preset temperatures, the times programmed into Timers as well as operating the Economy/Auto-Off and Pre-heat modes, to maintain comfort levels.

PRE-HEAT

This function will automatically operate the appliance before the programmed start time of the Timer, in order to heat a room to the pre-set temperature by the programmed time.

FILTER INDICATOR

When the fan filters become covered with dust, the filter indicator will flash. The filters should be vacuumed at regular intervals to avoid unnecessary strain on the appliance.

REMOTE CONTROL

For the convenience of operating the heater between STANDBY or ON, as well as adjusting the temperature up or down while at a short distance from the heater.

DUAL WEEKDAY / WEEKEND TIMER

The Dual WEEKDAY/WEEKEND Timer allows you to program the appliance to come on for two separate periods each day, one period in the morning and one period in the evening, on separate WEEKDAY and WEEKEND timers. The built in Pre-heat Mode brings the room temperature to the temperature you have selected, by the time programmed into the Timer.

The Dual Timer feature means that you can "Set and Forget" your heater. It will turn itself ON or to STANDBY at the times you have programmed until you cancel the Timer program.

ECONOMY / AUTO-OFF FUNCTION

The Economy / Auto-Off functions are energy saving feature designed to control the room temperature and are automatically selected in all modes.

IMPORTANT POINTS

Unpacking Appliance:

Check for damage. If the heater is damaged, contact your supplier for advice. Before installing the appliance, check it is labelled for the correct gas type (see label on rear of heater). Refer to local gas authority for confirmation of gas type if you are in doubt. The following items should also be included in the carton: Customers Operation Information, Remote Control, Remote Control Caddy and Batteries.



DO NOT modify this appliance.

Servicing shall be carried out ONLY by authorised personnel.

IMPORTANT

1. The appliance must be installed in accordance with the local gas and electrical authority regulations.
2. For information on gas consumption, see data plate on the appliance.
3. When using this appliance, ensure that the room is correctly ventilated. Check AS5601 (Gas Installations) or the local gas authority for information on ventilation requirements, or refer to the warning label located on the appliance.
4. **DO NOT connect this appliance to the gas supply to heat a bedroom. It may be connected to the electric supply for heating a bedroom in 'ELECTRIC' mode only.**
5. **DO NOT use this heater in the immediate surroundings of a bath, shower, swimming pool, toilet or sauna. The appliance must not be used to heat any of these areas.**
6. **DO NOT connect to an LPG Gas cylinder indoors.**
7. This appliance must not be installed where curtains or other combustible materials could come into contact with it. In some cases curtains may need restraining.
8. This appliance is not designed to be built in. Not intended for fireplace insert.
9. Heater must not be located below a power socket-outlet.
10. If you move house, check the gas type in the area where you are moving to.
11. The local gas and electrical authorities will be able to advise on local regulations.
12. Heat emanating from the front of this appliance may over time affect the appearance of some materials used for flooring such as carpet, vinyl, cork or timber. This effect may be amplified if the air in the room contains cooking vapours or cigarette smoke. To avoid this possibility, it is recommended that a mat be placed in front of the appliance, extending at least 750 mm in front of it.
13. The appliance is not intended for use by young children or infirm persons without supervision.
14. Young children should be supervised to ensure they do not play with the appliance.
15. If the supply cord or gas hose are damaged or require replacing, they must be replaced by the manufacturer or the manufacturer's agent or similarly qualified person in order to avoid a hazard.
16. The appliance weighs 21 kg. Exercise caution when lifting or moving.

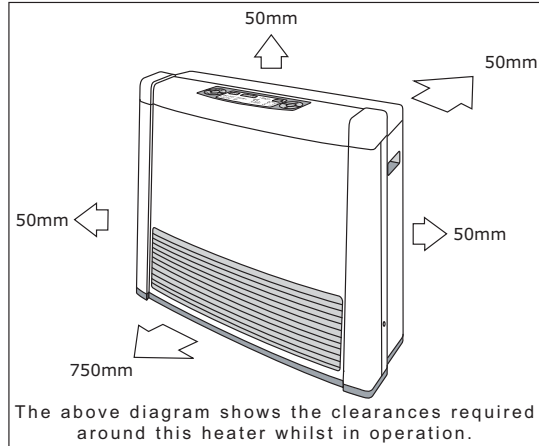

IMPORTANT POINTS

Do not allow children to post articles in the louvres.

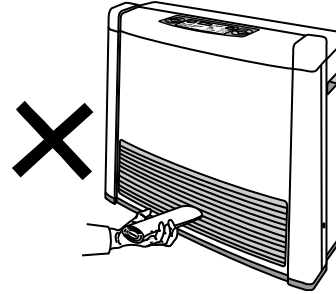

The appliance is not intended for use by young children or infirm persons without supervision.

Young children should be supervised to ensure they DO NOT play with the appliance.

Do not sit on this heater.

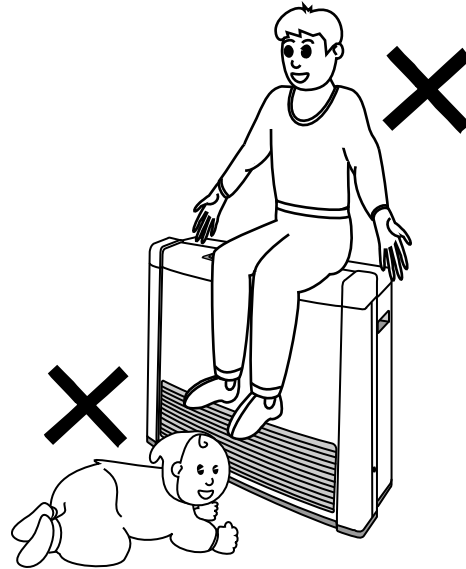

Do not allow children or elderly persons to sleep in the warm air discharge from the heater.

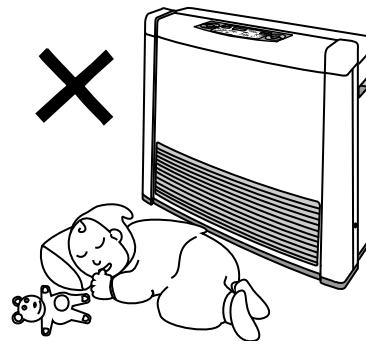

Do not cover or place articles on or against this appliance.

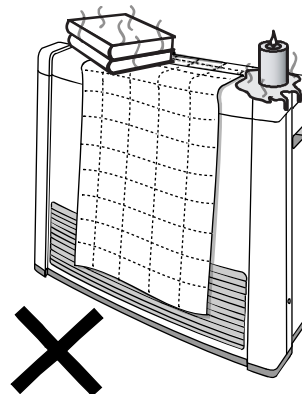

IMPORTANT POINTS

Do not operate/install this heater in areas where painting is taking place, or in places such as hairdressing salons, where there may be fluff and dust, and where aerosols are used.

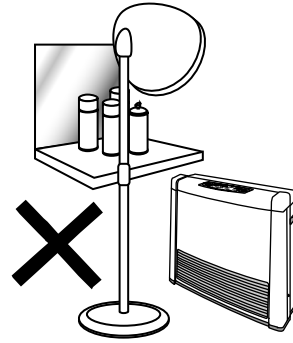

Turn the heater on to STANDBY after use.

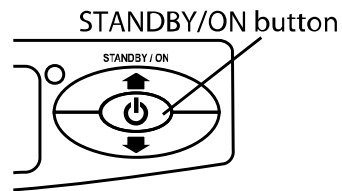

Keep heater away from flammable materials. DO NOT use or store flammable materials near this appliance.

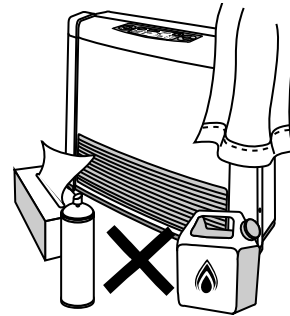

Do not spray aerosols near this heater while it is in the vicinity of this heater while it is in operation.

Most aerosols contain butane gas which can be a fire hazard if used near this heater when it is in use.

Use of aerosols, paint, polishes etc. whilst this heater is in use may also cause unpleasant smells.

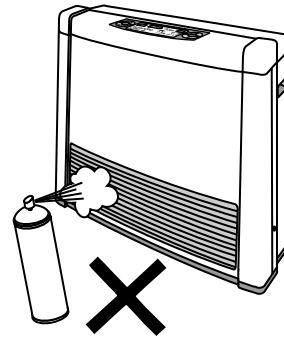

DO NOT modify this appliance.

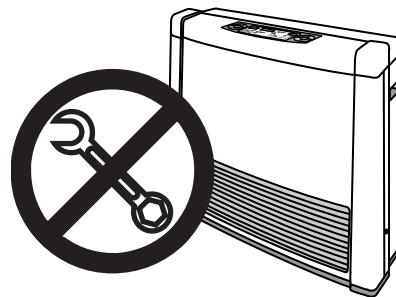

IMPORTANT POINTS

Do not place articles in front of the louvres.

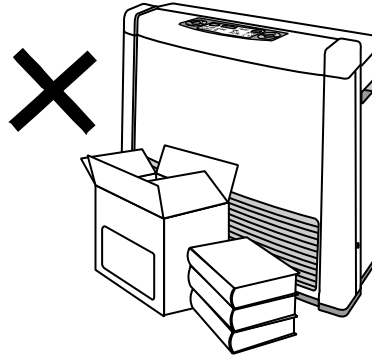

Do not move the heater whilst it is turned on.

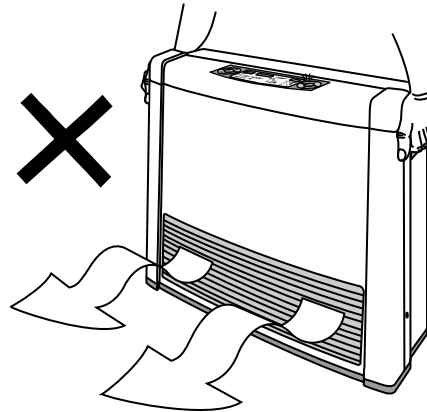

Do not unplug the heater while it is in operation or while the fans are still cycling.

Unplugging the heater will cause the timer and clock to stop, however programmed ON/OFF times will remain in the memory.

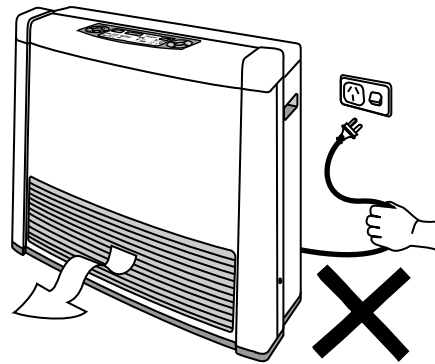

Do not place containers of liquid on top of the heater. Water spillage can cause extensive damage to the appliance and create an electrocution hazard.

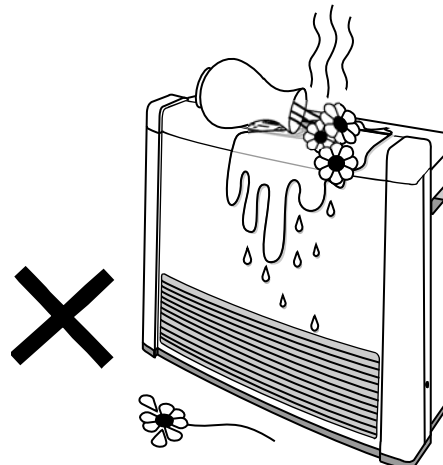

IMPORTANT POINTS

A dedicated 240v 10 Amp power point must be used with this appliance.

Do not use power boards or double adaptors to operate this appliance.

Heater must not be located below a power socket-outlet.

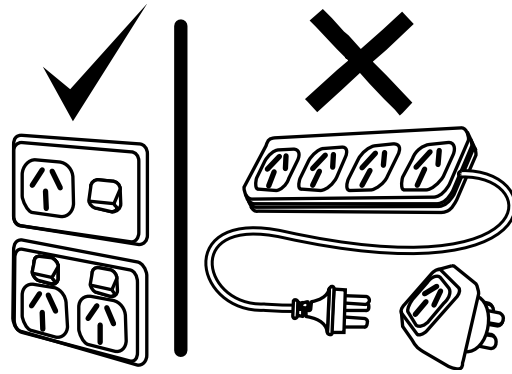

Heat emanating from the front of this appliance may over time affect the appearance of some materials used for flooring such as carpet, vinyl, cork or timber. This effect may be amplified if the air in the room contains cooking vapours or cigarette smoke. To avoid this possibility, it is recommended that a mat be placed in front of the appliance, extending at least 750 mm in front of it.

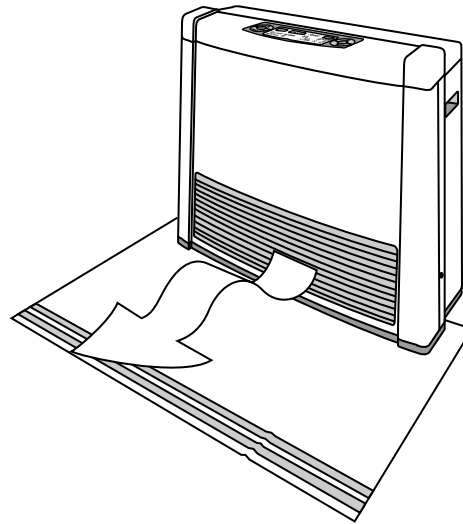

During peak operating periods the filters should be cleaned weekly, however if the "FILTER" warning indicator flashes in the control panel display, turn off the appliance immediately and clean filters before further use.

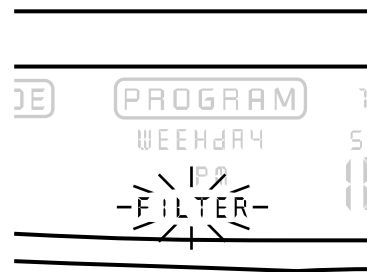

When the heater is operated for the first time or after long periods of non use a slight odour may be emitted, this is normal.

However if odours persist switch off the appliance and contact Rinnai.

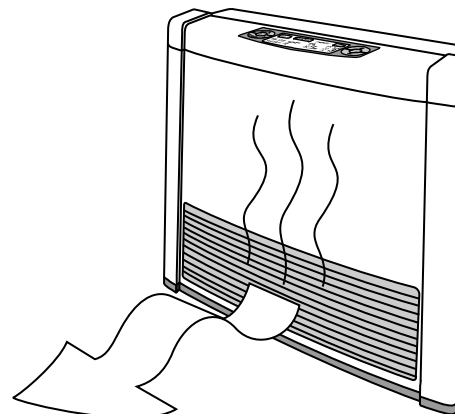

CUSTOMER OPERATING INSTRUCTIONS

INSTALLATION

Check room size and ventilation

This heater must not be installed in a room smaller than:

The AVENGER 25Plus must not be in a room smaller than 62.5 m^3 .

The CAPELLA 18Plus must not be in a room smaller than 45.0 m^3 .

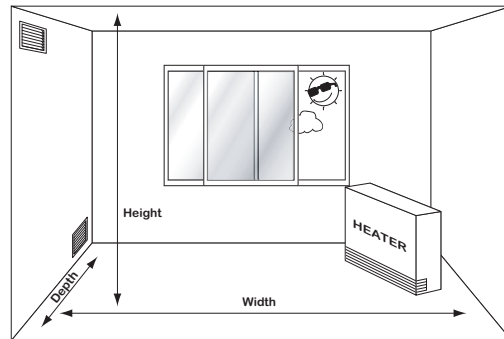

Fixed ventilation must conform to local regulations.

Number and position of vents is for illustrative purposes only. For more information on ventilation, please refer to our Rinnai Web Site www.rinnai.com.au

DO NOT install in a bedroom or bathroom.

The bayonet plug on the factory fitted flexible hose simply plugs into your bayonet fitting. The control panel is located on the top of the appliance, basic controls are also located on the remote control.

For the AVENGER - H x W x D must equal or exceed 62.5 m^3 .

For example: if room size is L 5.2 m x W 5.0 m x H 2.4 m the volume will be 62.4 m^3

For the CAPELLA - H x W x D must equal or exceed 45.0 m^3 .

For example: if room size is L 4.5 m x W 4.2 m x H 2.4 m the volume will be 45.4 m^3

This heater must not be installed where curtains or other combustible materials could come into contact with it. In some cases curtains may need restraining.

Other clearances are shown in the diagram.

This heater is not designed to be built in.

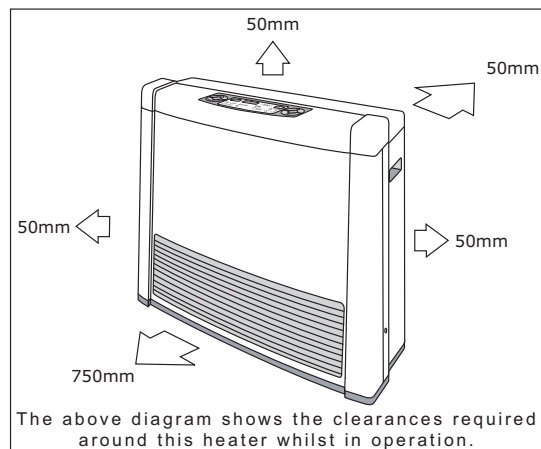

HOW TO OPERATE THE HEATER

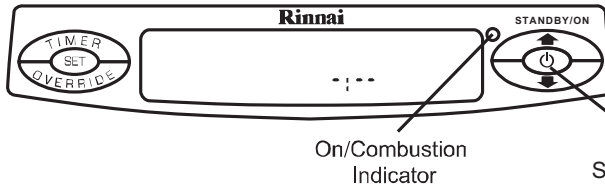

Before you begin, ensure that the Gas and Power have been connected correctly to the appliance.

To turn the heater On

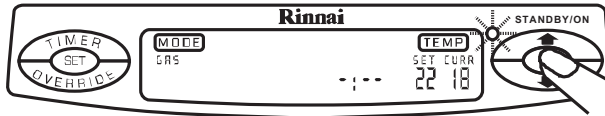

To turn the appliance ON press the "STANDBY/ON" button once.

When the "STANDBY/ON" button is pressed your heater will begin to operate in the following factory preset manner:

- The CLOCK display will default to - : - - (this applies if the clock has not been set - see page 15 on how to set the clock function).
- The SET temperature will default to 22° C. (See page 12 for setting room temperature).
- The CURRENT room temperature will be displayed.
- The MODE of operation will default to GAS or to that which was last used (See page 13 for MODE operation).
- The On/Combustion indicator will illuminate Green (steady). Ignition will take 5 ~ 10 seconds, the ON/Combustion indicator will change to Red (steady) after proper ignition has been achieved to signify the correct burner operation.

To return the heater to STANDBY

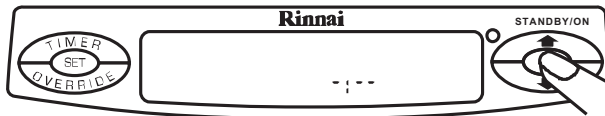

To return the heater to STANDBY while it is in operation press the "STANDBY/ON" button once.

The On/Combustion indicator will be extinguished.

After the indicator has gone out, the appliance's fans will continue to run on for several minutes, this is to lower the temperature within the appliance and is a normal operation, **DO NOT** disconnect the power during this time.



When using the appliance for the first time or after long periods of disuse, ignition may not occur the first time it is operated as there may be air within the pipes. If ignition does not occur after approximately 30-seconds the unit will cease operation automatically, if this occurs press the "STANDBY/ON" button twice to restart.

The unit may make noises after ignition/extinction. This is due to expansion and contraction of the heater components and is normal.

The heater will not ignite if the heaters "STANDBY/ON" button is pressed straight after extinction, After approximately 20 seconds has passed, the unit will automatically go into ignition mode.

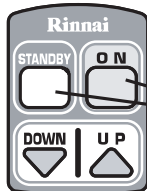

The "STANDBY" and "ON" buttons located on the remote control can also be used to operate the appliance.

Remote control STANDBY and ON Buttons

ADJUSTING TEMPERATURES

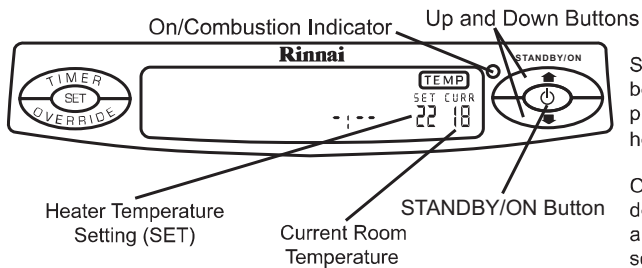

Setting or adjusting the room temperature can only be performed while the appliance is in operation, press the "STANDBY/ON" button once to turn the heater on.

Once the appliance is in operation it will be by default in the "TEMP" setting mode. When the appliance is used for the first time the factory default setting is set to 22° C. The appliance will thereafter default to the temperature setting last used.

To adjust temperatures settings.

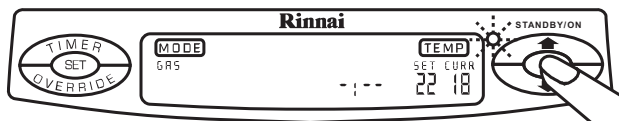

To turn the appliance on press the "STANDBY/ON" button once.

SET temperature increased to 25° C.

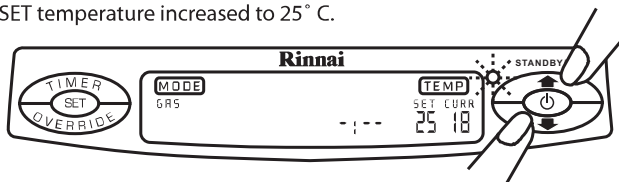

To raise the "SET" temperature press the  button until desired room temperature displayed.

SET temperature decreased to 20° C.

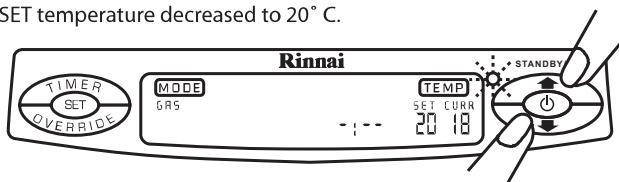

To lower the "SET" temperature press the  button until desired room temperature displayed.

- The following "SET" temperatures can be selected.
 1. 'L' for continuous combustion on lowest burner setting, without thermostatic control.
 2. Thermostatic control between 16° C to 26° C in 1° C steps
 3. 'H' for continuous combustion on highest burner setting, without thermostatic control.
- The current temperature "CURR" will display temperatures between 1° C to 30° C.
- Once the temperature is set it will be stored in the microcomputers memory, if the temperature is not adjusted further it will be available as the initial setting when the appliance is next used.



Rooms may not arrive at the "SET" temperature due to the size and construction of the room, location of the appliance or external temperatures.

If the appliance does not ignite then the pre-set temperature may already be higher than the actual room temperature.

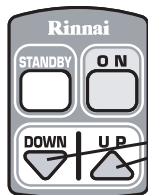

The "UP" and "DOWN" buttons located on the remote control can also be used to raise and lower the "SET" temperature.

Remote control UP and DOWN Buttons

HEATER MODES & FUNCTIONS

Your appliance has several "MODE" settings to choose from. The factory default setting is "GAS". For your convenience in normal operation the appliance's memory will select the "MODE" that was last used.

COMFORT AND ECONOMY

As a room is warmed, the walls and ceilings are also warmed, making one feel a little warmer than when the ceilings and walls were cold, even though the room temperature is the same. The Economy (ECON) function prevents discomfort from overheating and saves energy.

"GAS" MODE

When operating in this mode, the appliance will heat the room using gas convection. Gas combustion in this mode is continuous and will adjust automatically to maintain the "SET" temperature.

"GAS ECON" MODE

When operating in this mode, the appliance will heat the room using gas convection. Once the "SET" Temperature has been maintained for a period of 30 minutes, the comfort control system will progressively lower the "SET" temperature by 2°C over a period of 60 minutes. When 'ECON' only is selected, gas combustion is continuous and will adjust automatically to maintain the "SET" temperature minus 2°C.

Note: that during operation in this mode the "CURR" room temperature displayed may be lower than the "SET" temperature, however this is normal.

"GAS ECON AUTO OFF" MODE

When operating in this mode, the appliance will heat the room using gas convection. Once the "SET" temperature has been maintained for a period of 30 minutes, the comfort control system will progressively lower the "SET" temperature by 2°C over a period of 60 minutes. When 'ECON' & 'AUTO OFF' are selected, gas combustion will start and stop automatically to maintain the "SET" temperature minus 2°C.

Note: that during operation in this mode the "CURR" room temperature displayed may be lower than the "SET" temperature, however this is normal.

"GAS ELECTRIC" MODE

When operating in this mode, the appliance will heat the room using Gas convection or Gas and Electric convection. Electric convection is used only when the room is cold and/or when the heat load is high. Gas combustion in this mode is continuous and will adjust automatically whilst the electric convection is turned on and off to maintain the "SET" temperature.

"GAS ECON ELECTRIC" MODE

When operating in this mode, the appliance will heat the room using Gas convection or Gas and Electric convection. Electric convection is used only when the room is cold and/or when the heat load is high. Once the "SET" temperature has been maintained for a period of 30 minutes, the comfort control system will progressively lower the "SET" temperature by 2°C over a period of 60 minutes. When 'ECON' only is selected, gas combustion is continuous and will adjust automatically to maintain the "SET" temperature minus 2°C.

Note: that during operation in this mode the "CURR" room temperature displayed may be lower than the "SET" temperature, however this is normal.

"GAS ECON ELECTRIC AUTO OFF" MODE

When operating in this mode, the appliance will heat the room using Gas convection or Gas and Electric convection. Electric convection is used only when the room is cold and/or when the heat load is high. Once the "SET" temperature has been maintained for a period of 30 minutes, the comfort control system will progressively lower the "SET" temperature by 2°C over a period of 60 minutes. When 'ECON' & 'AUTO OFF' are selected, gas combustion will start and stop automatically to maintain the "SET" temperature minus 2°C.

Note: that during operation in this mode the "CURR" room temperature displayed may be lower than the "SET" temperature, however this is normal.

"ELECTRIC" MODE

When operating in this mode, the appliance will heat the room using Electric convection. The Electric element will switch on and off automatically to maintain the "SET" temperature.

Note: Electric convection will only operate when the "SET" temperate is at least 2°C higher than the "CURR" temperature. Timer operation is disabled when the appliance is in the "ELECTRIC" only mode.

SETTING HEATER MODES

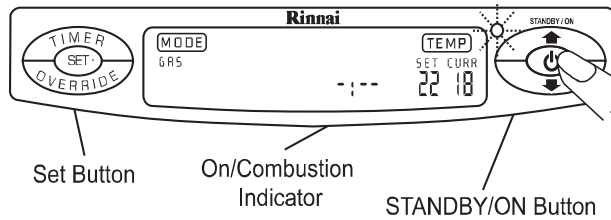

Step 1.

Press the "STANDBY/ON" button once. The On/Combustion indicator will illuminate Green (steady). Ignition will take 5 ~ 10 seconds, the On/Combustion indicator will change to Red (steady) after proper ignition has been achieved to signify the correct burner operation. The factory default heater "MODE" will be "GAS", otherwise the "MODE" will default to that which was last used.

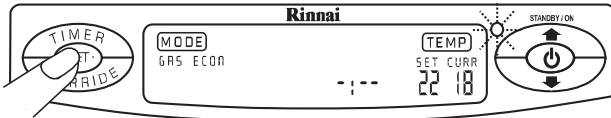

Step 2.

From the "GAS" mode press the "SET" button once to choose the "GAS ECON" mode." The On/Combustion indicator will be illuminated Red (steady) during operation in this mode.

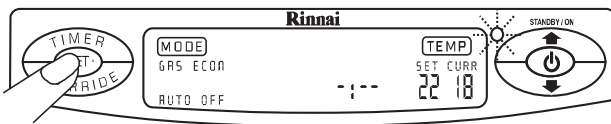

Step 3.

From the "GAS ECON" mode press the "SET" button once to choose the "GAS ECON AUTO OFF" mode. The On/Combustion indicator will be illuminated Red (steady) during operation in this mode.

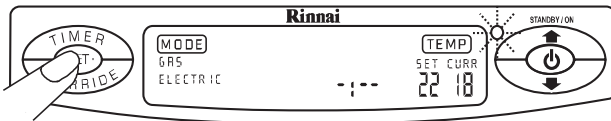

Step 4.

From the "GAS ECON AUTO OFF" mode press the "SET" button once to choose the "GAS ELECTRIC" mode. The On/Combustion indicator will be illuminated Red (steady) during operation in this mode.

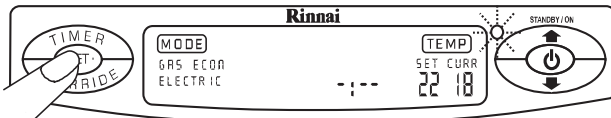

Step 5.

From the "GAS ELECTRIC" mode press the "SET" button once to choose the "GAS ECON ELECTRIC" mode. The On/Combustion indicator will be illuminated Red (steady) during operation in this mode.

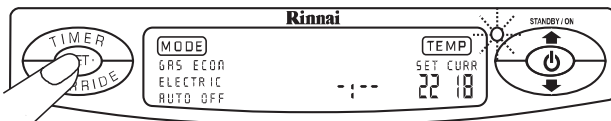

Step 6.

From the "GAS ECON ELECTRIC" mode press the "SET" button once to choose the "GAS ECON ELECTRIC AUTO OFF" mode. The On/Combustion indicator will be illuminated Red (steady) during operation in this mode.

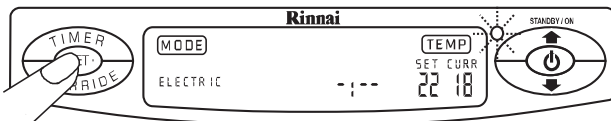

Step 7.

From the "GAS ECON ELECTRIC AUTO OFF" mode press the "SET" button once to choose the "ELECTRIC" mode. The On/Combustion indicator will be illuminated Green (steady) during operation in this mode.

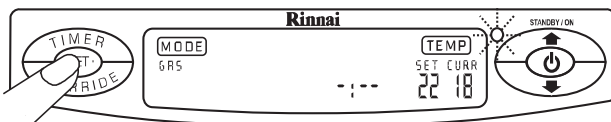

Pressing the "SET" button once will return you to "GAS" mode. Re-ignition will take 5 ~ 10 seconds, the On/Combustion indicator will change to Red (steady) after proper re-ignition has been achieved.

Note: The Economy and Auto-Off functions will not operate when the "SET" temperature is "H". When using the Economy and Auto-Off function the current room temperature "CURR" may be lower than the "SET" room temperature, however this is normal.

SETTING CLOCK

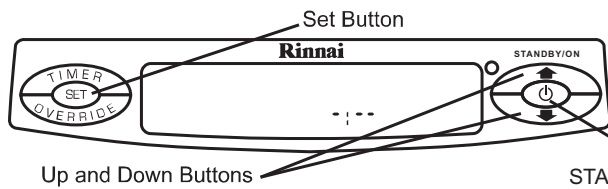

When the appliance is plugged in for the first time the control panel display will show - : - and the heater will be in the STANDBY condition.

Step 1.

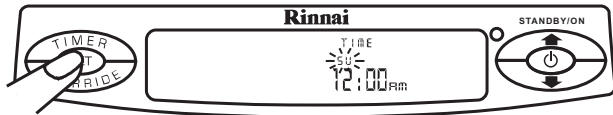

With the heater in the OFF condition press the "SET" button once to enter the "TIME" function, the clock display will show SU 12:00 AM, with the day indicator flashing.

Step 2.

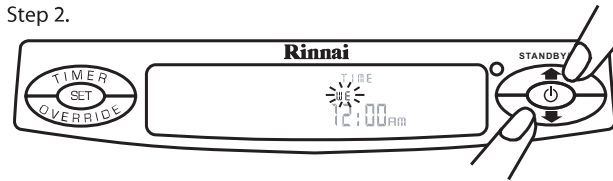

As an example let's set the clock to Wednesday 8:53 pm.

Press or buttons to scroll to the desired day of the week, in this case select WE for Wednesday.

Step 3.

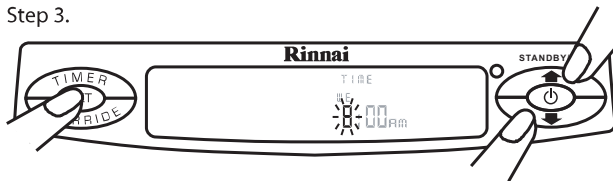

After setting the desired day, press the "SET" button once, the day indicator will cease flashing and the hour digits will begin to flash.

Press or buttons to scroll numbers to set hour, in this case select the digit 8.

Step 4.

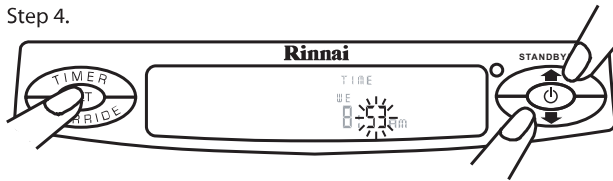

After setting the desired hour, press the "SET" button once, the hour digits will cease flashing and the minute digits will begin to flash.

Press or buttons to scroll numbers to set minutes, in this case select the digits 53.

Step 5.

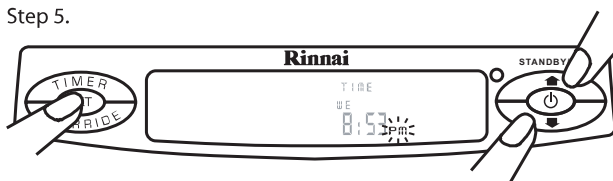

After setting desired minutes, press the "SET" button once, the hour digits will cease flashing and the AM indicator will begin to flash.

Press or buttons to set AM or PM, in this case select PM.

Step 6.



After setting AM or PM, press the "SET" button once and then press the "STANDBY/ON" Button twice to the save new time setting. To alter the clock at a later date, with the heater in the STANDBY condition, press the "SET" button once and repeat the previous steps.

PROGRAMMING THE ON/OFF TIMERS

Here we will learn how to set the Timer (s) function by following the steps below.



Before programming the Timers you must ensure that the clock has been set to the correct time, see previous section **SETTING CLOCK** for instructions. Note: After setting Clock you can proceed directly to the setting of the Timers by pressing the "SET" button once, after setting the AM or PM for the CLOCK, "PROGRAM" will be shown in the control panel display to indicate that the heater is in the Timer programming mode.

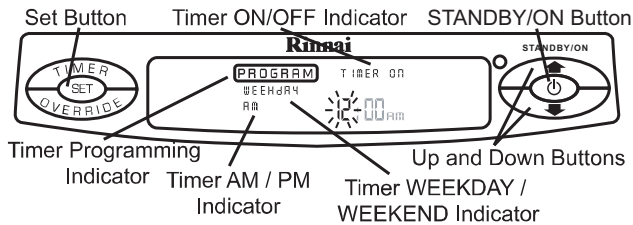

With the heater in the STANDBY condition press the "SET" button until "PROGRAM" is shown in the control panel display and the hour digits are flashing.

Step 1.

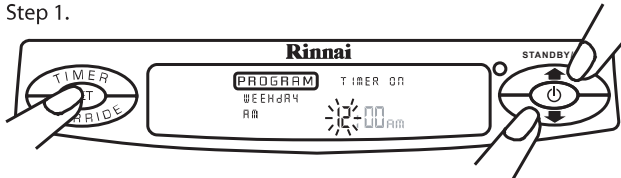

Press or buttons to scroll through to set the desired "TIMER ON" hours for the "WEEKDAY AM" timer.

Step 2.

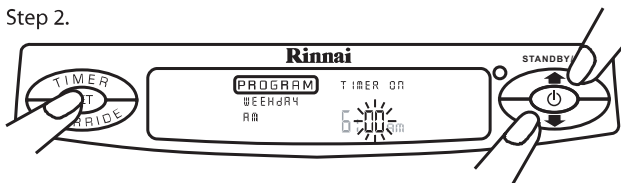

Press the "SET" button once and press or buttons to scroll to the desired "TIMER ON" minutes for the "WEEKDAY AM" timer.

Step 3.



Press the "SET" button once and press or buttons to scroll to the desired "TIMER ON" AM or PM for the the "WEEKDAY AM" timer.

Step 4.



Press the "SET" button once and press or buttons to scroll to the desired "TIMEROFF" Hours for the "WEEKDAY AM" timer.

Step 5.

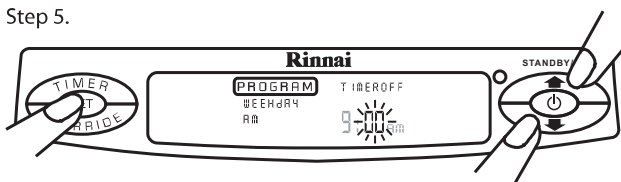

Press the "SET" button once and press or buttons to scroll to the desired "TIMEROFF" Minutes for the "WEEKDAY AM" timer.

Step 6.



Press the "SET" button once and press or buttons to scroll to the desired "TIMEROFF" AM or PM for the "WEEKDAY AM" timer.

Press the "SET" button and repeat above steps for setting the "WEEKDAY PM", "WEEKEND AM" and "WEEKEND PM" timers.

Note: If the time is correct do not press the arrow keys , just press "SET" again.

OPERATING THE ON/OFF TIMERS

Now that the timer (s) functions have been programmed they can operated as follows.

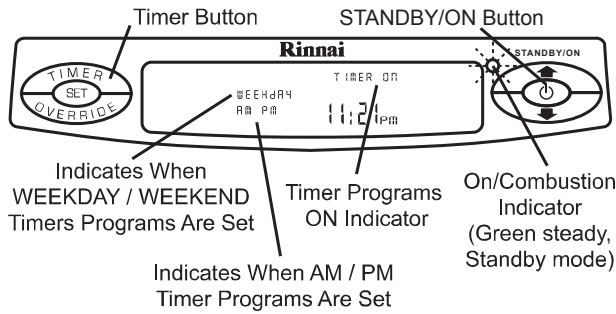

Press the "STANDBY/ON" button once to turn heater on, select an appropriate Mode and Temperature. Please note that the appliance timer function may be operated in all modes except for the "ELECTRIC" only mode.

When a timer program is running the selected program is displayed along with a relevant flashing AM or PM as shown below.

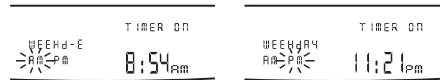

Weekday program on.



Press the "TIMER" button once or until the "WEEKDAY" program is shown, any on/off timers that have been set will be displayed momentarily, before the display reverts to show the current time, the On/Combustion indicator will remain illuminated Green (steady) to confirm that the appliance is awaiting a timer operation to begin.

Weekend program on.



Press the "TIMER" button until the "WEEKEND" program is shown, any on/off timers that have been set will be displayed momentarily, before the display reverts to show the current time, the On/Combustion indicator will remain illuminated Green (steady) to confirm that the appliance is awaiting a timer operation to begin.

Weekday / Weekend programs on.



Press the "TIMER" button until the combined "WEEKDAY / WEEKEND" programs are shown, any on/off timers that have been set will be displayed momentarily, before the display reverts to show the current time, the On/Combustion indicator will remain illuminated Green (steady) to confirm that the appliance is awaiting a timer operation to begin.

Timer programs off.

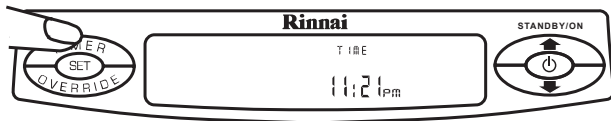

To return the appliance to the STANDBY condition, press the "TIMER" button until no programs are displayed, the On/Combustion indicator will be extinguished and the clock will be displayed to confirm that the heater is now in the STANDBY condition and that no timer programs are selected.

PRE-HEAT

This function operates automatically in conjunction with the Timers. When a Timer is selected, the heater may operate anywhere within an hour prior to the programmed starting time of a Timer.

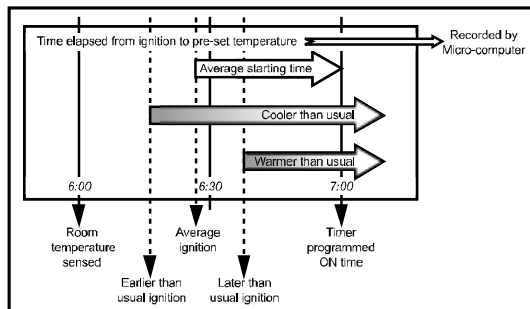

This function is called Pre-heat since it ensures the room reaches the desired temperature by the time the Timer programs On time. The room temperature is sensed one hour before reaching Timers programmed ON time.

The temperature differential at the time of sensing the room temperature combined with the data from previous operation governs exactly how long before the programmed ON time the micro-computer will operate the heater and ignite the burner.

OVERRIDE FUNCTION

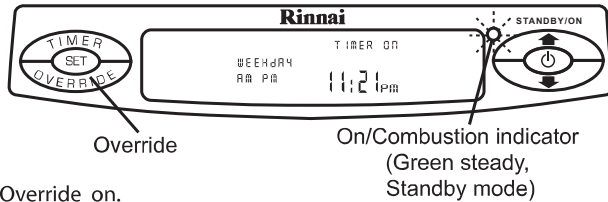

Override on.

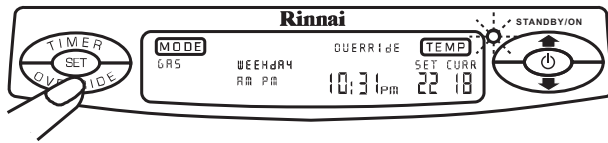

Return to Set Timer Programs.



This function is used to manually override the current operation of the heater. For example: if the heater is between the finishing and starting times of a timer program and the Override button is selected, then the heater will begin to operate and heat the room.

The heater must be between the finishing and starting times of a timer program for the Override to function to work, "TIMER ON" is shown in the control display and the On/Combustion indicator is illuminated Green (steady) when this is the case. Press the "OVERRIDE" button once to turn heater on, the heater Mode and Temperature controls are now available.

Press the "OVERRIDE" button once to return to the timer programs, "TIMER ON" is shown in the control display and the On/Combustion indicator is illuminated Green (steady) to confirm that the heater is awaiting a timer operation to begin, If the "OVERRIDE" button is not pressed the heater will remain on until the next Timer Off setting is reached. If the "STANDBY/ON" button is pressed the heater will be turned off and the timer programs will not operate.

USING THE REMOTE CONTROL

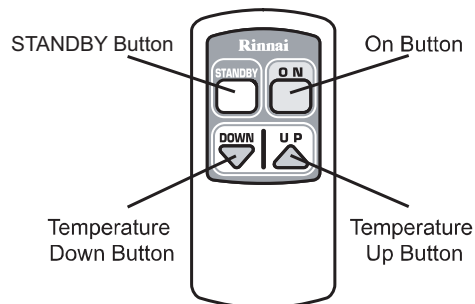

Heater in Stand by.



Heater On.



Override On.



The remote control can only be used when the heater is in STANDBY, ON or in OVERRIDE modes. If the heater is between the finishing and starting times of a timer program the remote control will have no effect.

The remote control is able switch the heater between STANDBY or ON and adjust the heater temperature UP or DOWN.

Note: Some fluorescent lights may interfere with the transmission of remote control signals, in this case changing the position from which you are operating the remote control may help.

Avoid leaving the remote control in direct sunlight and do not place the remote control close to the louvres of the heater.

Avoid getting the remote control wet, or dropping it.

If the heater is STANDBY Press the "ON" button once (an audible beep will confirm that the heater has received signal). After ignition you can alter the temperature UP or DOWN remotely by using the appropriate buttons on the remote control. Each press will be confirmed by an audible beep.

If the heater is ON or in OVERRIDE mode the remote control can then alter the temperature UP or DOWN remotely by using the appropriate buttons on the remote control. Pressing the "STANDBY" button once will return the heater to STANDBY.

Note: If the heater was operating in an OVERRIDE mode and the remote control has been used to return the heater to STANDBY, then the Timer programs will no longer operate.

CHILD LOCK

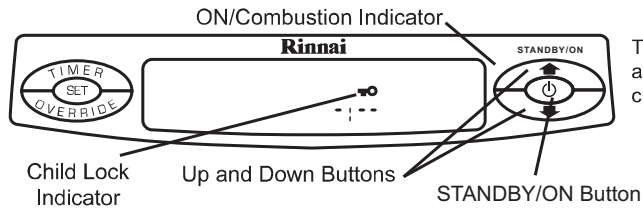

The "CHILD LOCK" function will help to avoid accidental operation as well as to prevent small children from altering the heater settings.



When the "CHILD LOCK" is operated whilst the heater is running or in "TIMER" mode, all controls other than the ability to turn the appliance to "STANDBY" will be locked out until the "CHILD LOCK" is released. Timer operation will not be affected. Turning the appliance to "STANDBY" whilst the "CHILD LOCK" is activated or activating the "CHILD LOCK" whilst the appliance is in the "STANDBY" condition will lock out all the controls until the "CHILD LOCK" is released.

The "CHILD LOCK" state is stored in the appliance's microprocessor, unplugging the appliance from the power supply will have no effect on the "CHILD LOCK" state.

Activating the Child Lock.

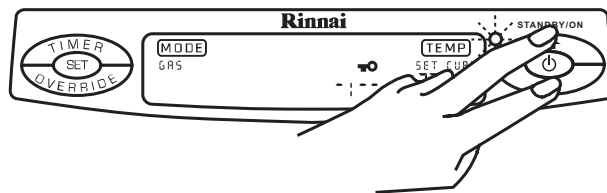

To activate the "CHILD LOCK" function press both the  and  buttons simultaneously for 3 seconds.

The function is activated immediately and the "CHILD LOCK" indicator is displayed.

Deactivating the Child Lock.

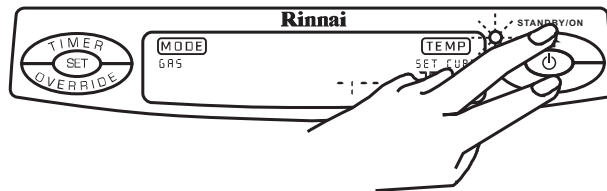

To deactivate the "CHILD LOCK" function press both the  and  buttons simultaneously for 3 seconds.

The "CHILD LOCK" indicator will no longer be displayed, the "CHILD LOCK" function can be deactivated at any time in this manner.

SAFETY DEVICES

OVER HEAT SWITCH

When the heater gets too hot during operation (for example when the filters or air outlet louvers are blocked) this device turns the gas and or electric heating element off automatically. Remove cause of overheat (clean filters) allow heater to cool, then re-ignite.

FUSE

The electrical circuits are protected by a fuse. When the fuse blows, the heater will not operate at all. The fuse must be replaced by an authorised person.

FLAME FAILURE DEVICE

This device automatically cuts off the gas supply to the heater in the event of a gas failure. To restore the gas supply to the heater, turn it off, and then follow the ignition procedure.

OXYGEN DEPLETION SAFETY DEVICE

If the oxygen level in the room drops below a pre-set limit, this device cuts the gas supply to the heater. If the oxygen depletion device operates, turn the heater off, ventilate the room, then follow the ignition procedure to re-light. Heater will not re-light until room is fully ventilated.

TILT SWITCH

If the heater is knocked over, the tilt switch will cut the gas supply and or the power to the electric heating element. The fan keeps running. To restore the gas supply, stand the heater upright, turn it off then follow the ignition procedure. The tilt switch may also operate if the heater is jolted or picked up whilst in operation.

POWER FAILURE

In the event of a power failure or power cut, the gas valves will automatically close. After the power is re-instated the appliance must be operated manually.

CARE OF HEATER

Your heater needs very little maintenance, but the following information will help you to keep it looking good, and working efficiently.

- Unplug before cleaning.
- All parts of the heater can be cleaned using a soft, damp cloth.
- Do not use solvents to clean any parts.
- Do not spray aerosols in the vicinity of the heater whilst in operation.
- Do not place articles on or against this heater.
- Do not store flammable materials near this heater.

AIR FILTERS

Dusty filters reduce the air flow through the heater as well as reducing the heater's effectiveness. Do not wait for filter warning lamp to come on before cleaning filters. Do not use the heater with the filter warning lamp on, this may cause it to overheat.

REMOVING FILTERS

Filters require cleaning at least once a week during the heating season to prevent unnecessary cut-out due to a build up of dust particles.

For cleaning Filters 1 & 2, undo and remove the retaining screw (ensuring to store the retaining screw in a safe place)

Carefully lift filters up then backwards to remove from locating tabs.

With the careful use of a vacuum cleaner, gently remove any contaminates such as dust and lint.

Replace filters by carefully repositioning the location tabs and fasten in place with the retaining screw.

Filter 3 (the small filter) should be left in position for cleaning, carefully use a vacuum cleaner to remove any contaminates such as dust and lint.

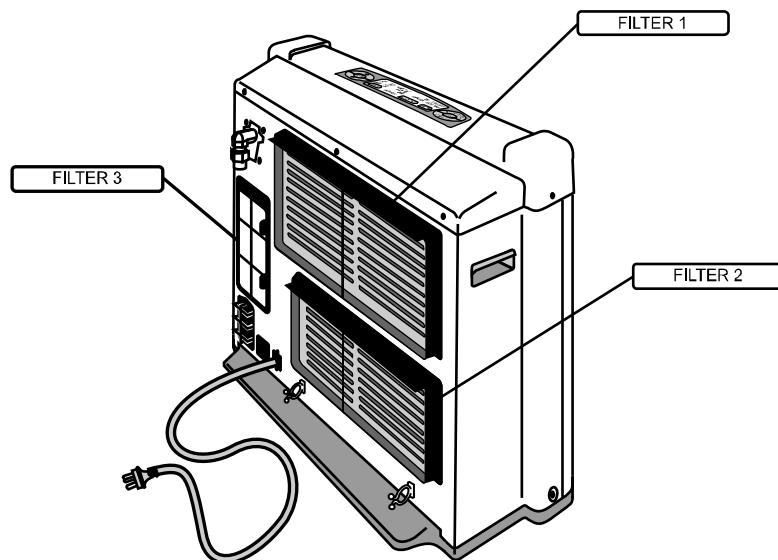

TROUBLE SHOOTING

Please note: Service calls for general cleaning, maintenance and wear and tear are not necessarily covered under the guarantee. Service calls of this nature may be chargeable.

Problem Cause	No Display	Burner doesn't ignite	Filter indicator shown in display	Combustion stops during operation	Smell of gas	Takes too long to warm the room	Remote control doesn't work	Remedy
Not Plugged In	●	●						Plug In
Power Cut	●	●		●			●	Re-ignite manually after power is restored
(Initial Installation) Air in gas pipe		●						Purge air (Installer)
Air in the hose		●						Repeat ignition procedure
Room too large						●		Check with retailer
Dust on air filters			●					Clean the air filters (WEEKLY)
Louvre obstructed				●		●		Remove obstruction
Air filter blocked				●		●		Clean the air filters (WEEKLY)
Gas Escape					●			Service Call (Contact Rinnai)
On Timer is set		●						Cancel On Timer (Select override)
Child Lock set		●						Cancel Child Lock
Gas turned off at meter	●	●						Turn gas on
Battery flat (remote control)							●	Replace battery

SERVICE

Rinnai recommend that this appliance be serviced every 2 years.

If the power supply cord, gas supply hose or any other component of the heater is damaged, they must be replaced by Rinnai or a suitably qualified person.

Any service or repair work should only be carried out by an authorized person.

Rinnai Australia has service and spare parts departments.

Fault Finding Procedure

If you are unsure about the way your heater is operating, contact Rinnai Australia, or your local agent.

ERROR CODES

Your appliance has the ability to check its own operation continuously. If a fault occurs an Error Code will flash on the digital display of the control panel. This assists with diagnosing the fault and may enable you to overcome a problem without a service call. Please quote the Error Code displayed when enquiring about service.

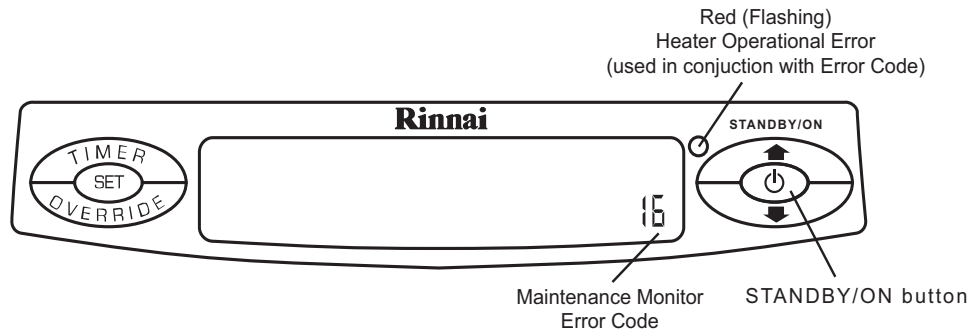

Error Code	Probable Cause	Comments
00	Power failure while STANDBY/ON switch ON	Switch the Heater to STANDBY and then ON again
03	Tilt switch is activated	Ensure unit is level & upright, service call if repeated
10	Overheat (Electric heater)	Check & clean Filters, Service call if repeated
11	Ignition failure	* Check gas supply is turned on, Switch the Heater to STANDBY and then ON again. Service call if repeated.
12	Incomplete combustion	Service call
13	Combustion control faulty	Service call
14	Overheat	Service call
16	Room Overheat	Lower room temperature to less than 40° C
18	Thermocouple Temperature Error	Thermocouple failed to read the prescribed temperatures during the 1st eighty seconds of operation. Check gas cylinder (LPG models only) and check air filters.
30	Temperature sensor faulty	Service call
31	Room temperature sensor faulty	Service call
32	Room temperature sensor faulty	Service call
33	Overheat temperature sensor faulty	Service call
34	Overheat temperature sensor faulty	Service call
35	Temperature sensor faulty	Service call
60	Electric heater element faulty.	Service call
62	Faulty fan motor	Service call
70	STANDBY/ON Switch faulty	Service call
71	Faulty solenoids	Service call
72	Flame detection circuit faulty	Service call
73	Communication error	Switch the Heater to STANDBY and then ON again

* Make sure that the gas supply is on, also it is quite possible that there are pockets of air in the supply hose or in the heater itself and these will need to be purged, if heater fails to ignite on initial attempt try 3 to 4 more times, however if the heater ignition continues to be unsuccessful arrange a service call.

SPECIFICATIONS

DIMENSIONS

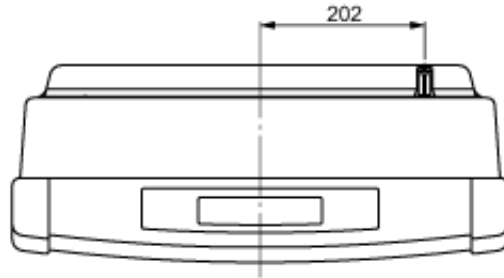

Weights	
Avenger 25 Plus	17.5kg
Capella 18 Plus	17.5kg

All dimensions are in mm

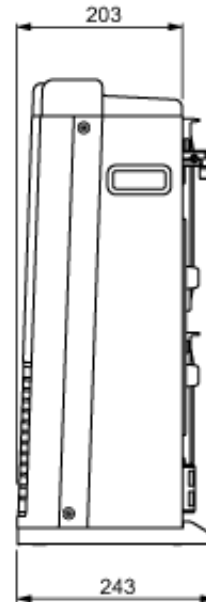
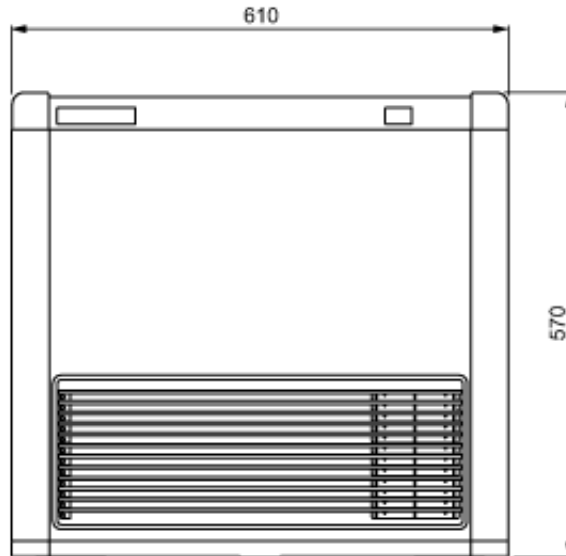

Refer to appliance data plate for Gas Type, Gas Rates and Burner Pressures.

GENERAL SPECIFICATIONS

General Description	Portable Gas Convector Heaters	
Gas Control	Electronic Control	
Burner	Surface Combustion Burner	
Gas Connection	3/8" MI BSP into 1.5m flexible hose with bayonet connection	
Convection Fan	Multi-Speed Fan	
Ignition System	Continuous Spark electronic Ignition	
Operation	Push Button Electronic/Remote Control	
Safety Devices	Overheat Switch Electric Fuse Flame Failure Sensor	Oxygen Depletion Sensor Tilt Switch Power Failure Sensor
Electric Booster	Avenger 25 Plus - 2000 W	Capella 18 Plus - 2000 W

SPECIFICATIONS

WIRING DIAGRAM

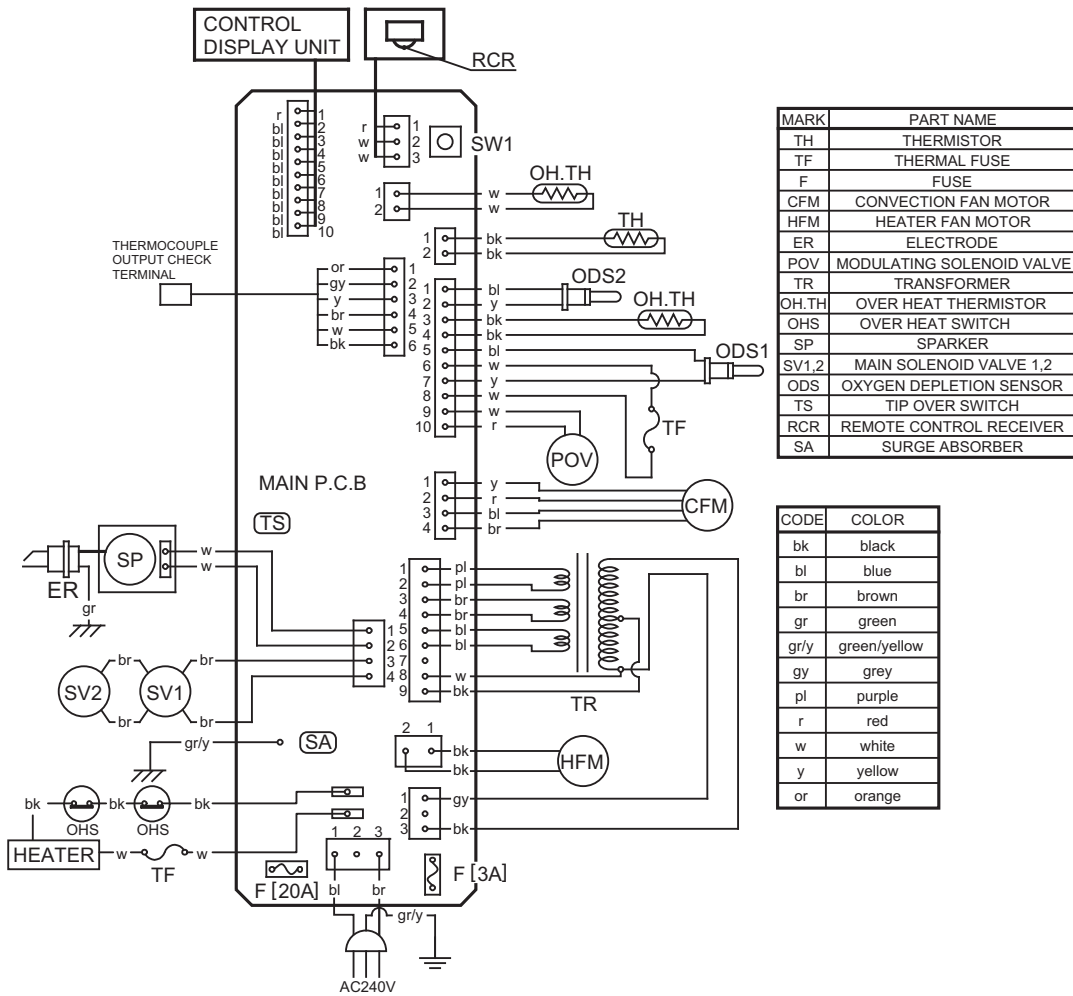

BLOCK DIAGRAM

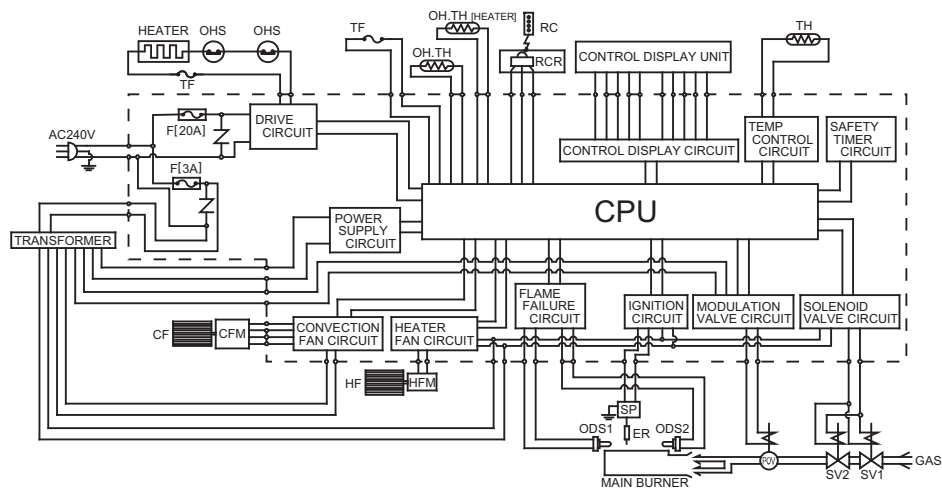

Rinnai

Rinnai Australia Pty. Ltd. ABN 74 005 138 769

Head Office

100 Atlantic Drive
Keysborough, Victoria 3173
P.O. Box 460
BRAESIDE VIC. 3195
Tel: (03) 9271 6625
Fax: (03) 9271 6622

Rinnai has a Service and Spare Parts network with personnel who are fully trained and equipped to give the best service on your Rinnai appliance. If your appliance requires service, please call our Service Line. Rinnai recommends that this appliance be serviced every 2 years.

Internet: www.rinnai.com.au E-mail: enquiry@rinnai.com.au

National Help Line

Tel: 1300 555 545* Fax: 1300 555 655*

**Cost of a local call Higher from mobile or public phones.*



102646

RC -670-93x08(00)